



SANDHYA ENTERPRISES

AN ISO 9001:2015 Certified Company

Address: 5-24-1223/8/1, Ambedkar Nagar, Gajularamaram, Hyderabad – 500055.

AN ISO 9001:2015 Certified Company

Contact No: 9652998932

GSTIN: 36GNLPS1299P1ZS

Email : sandhyapprises@gmail.com

Website: www.sandhyaflex.com

WhatsApp: 9652998932

YouTube: www.youtube.com/c/SANDHYAENTERPRISES

Website : <http://www.sandhyaflex.com/pvc-water-...>

Request a Quote : <https://www.sandhyaflex.com/contactus-1.php>

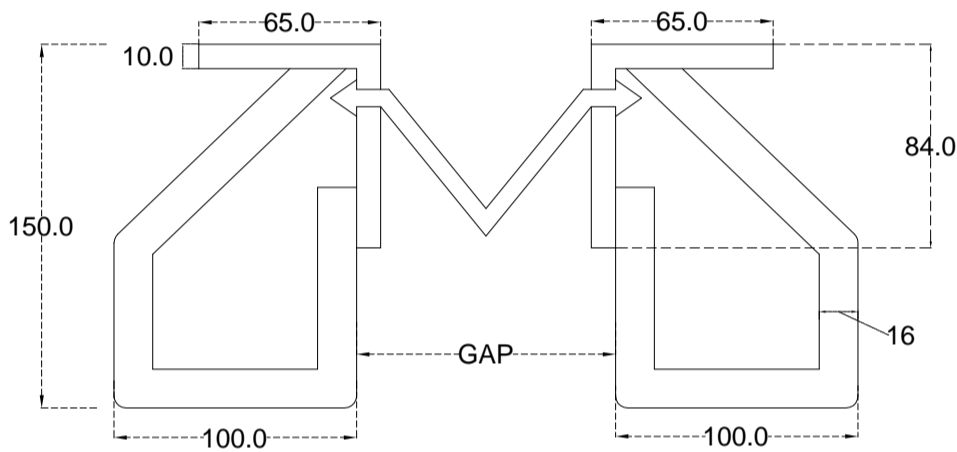

CROSS SECTION OF STRIP SEAL EXPANSION JOINT

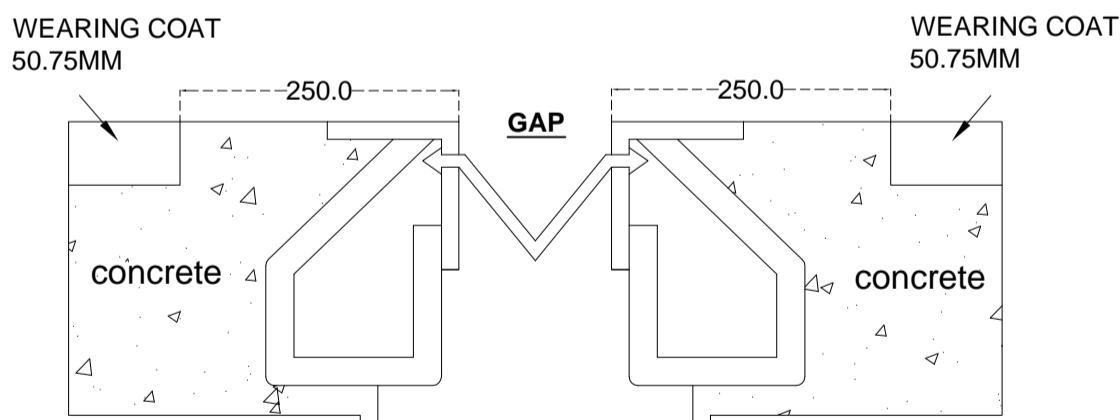

CROSS SECTION VIEW AFTER INSTALLATION

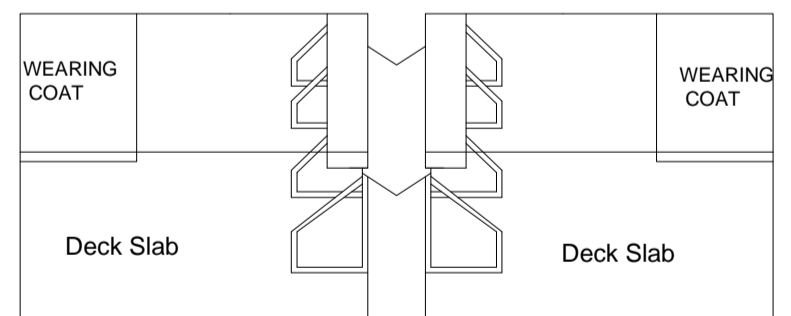

Strip Seal in Deck Slab

All Dimensions are in MM

STRIP SEAL EXPANSION JOINT

TITLE:	DRAWING NO:	DRAWN BY:	 SANDHYA ENTERPRISES HYDERABAD
STRIP SEAL EXPANSION JOINT	SE/SSEJ/65/2020-21	MD. RAHMATH ALI (B.TECH CIVIL ENG)	
		CHECKED BY:	
		MITHILESH CHOUDHARY	